

Your Advantages

- Compact CAN-operation
- Graphical programming
- Quick and easy installation
- Various input- / output module digital / analogue available

Features

- According to IEC/EN 61 131-2, EN 50 178
- Operation as master
 - Operation as slave
 - Transfer rate up to 1 Mb/s
 - Interface according to DS301 version 3.0
- IN 5504 locally extendable with digital and analogue in- / output modules
- 2 digital inputs for DC 24 V
- 2 relay outputs
- LED indicators
- Standard programming software CODESYS® under Windows according to IEC/EN 61131-3:
 - Instruction set
 - Ladder diagram
 - Function block diagram
 - Sequential function chart
 - Structured text (similar to Pascal)
- 128 KB Flash memory for user program
- 128 KB RAM for user data
- 16 KB battery buffered RAM for no-voltage safe data
- Battery buffered real time clock
- Monitoring contact for RUN status of the PLC
- IL 5504: 35 mm width
- IN 5504: 52.5 mm width

Circuit Diagrams

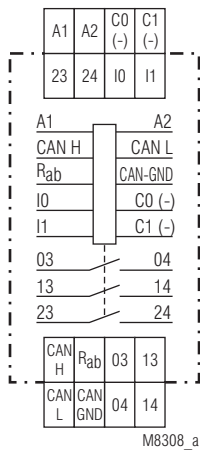

IL 5504

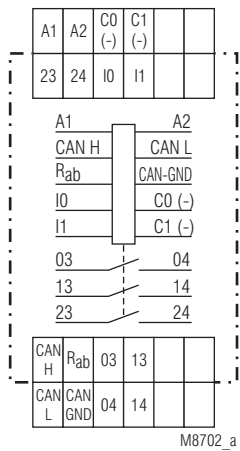

IN 5504

Additional Information

- Data sheet Input Module IP 5502
- Data sheet Output Module IP 5503
- Data sheet Emergency Stop Monitor BH 5922
- Data sheet Power Supply IR 5592
- Data sheet Analogue Output Module IL 5507
- Data sheet Analogue Input Module IL 5508
- Data sheet Input- / Output Module IN 5509

Approvals and Markings



Application

The PLC runs a user program edited with the programming software PN 5501. The program can process local I/Os on the PLC as well as remote I/Os via the CANopen bus.

Indicators

- | | |
|---------------------|--|
| green LED „ON“: | on, when supply connected |
| yellow LED „BUS“: | on, when bus is active |
| yellow LED „RUN“: | on, when PLC in RUN state
flashing, when failure |
| green LED „I0, I1“: | on, when corresponding input is active (I0/C0-, I1/C1-) |
| red LED „O1, O2“: | on, when corresponding output relay is active (O3/O4, 13/14) |

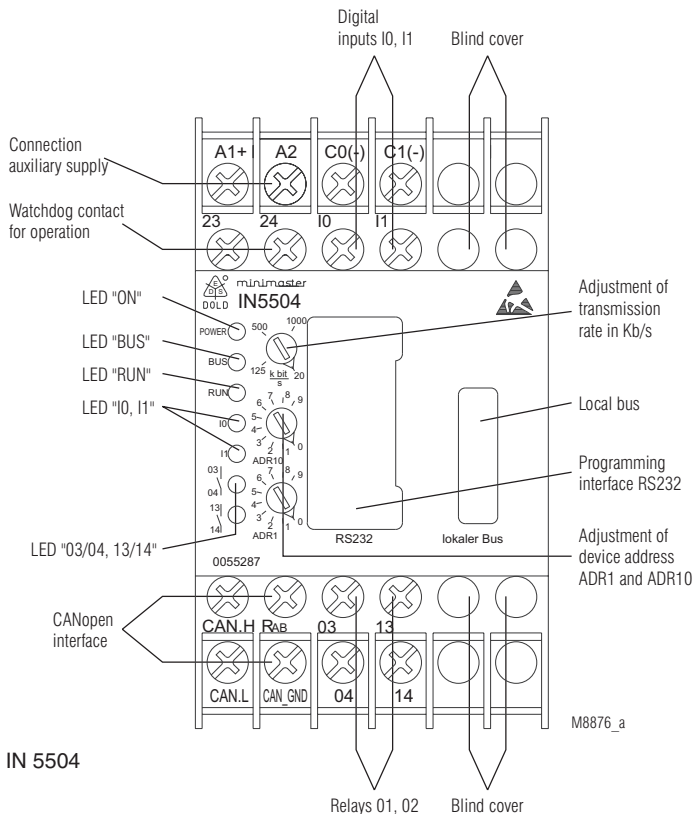
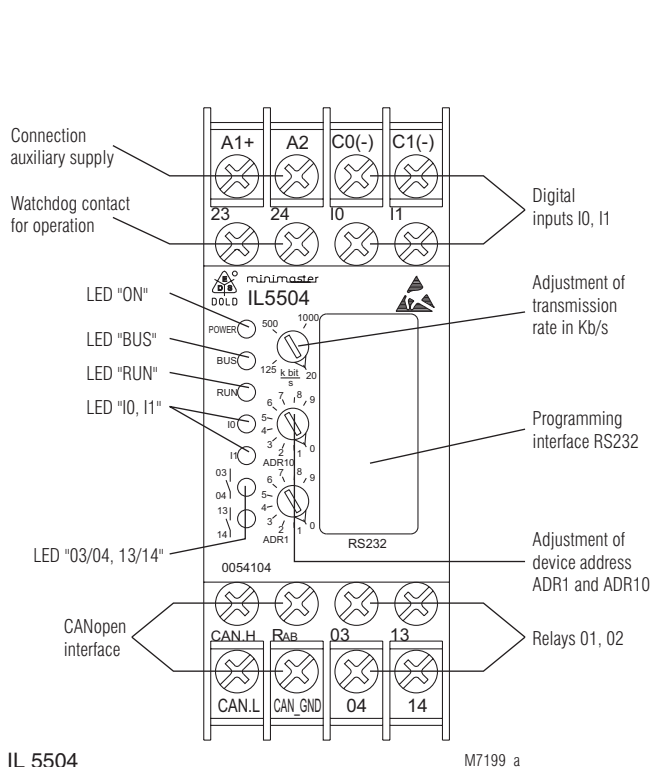

Adjustment of address:

To allow communication on the CANopen-Bus the device address has to be set with the 2 rotational switches between 1 ... 99.

Set-up Procedure:

- 1.) Connect device to CANopen-bus
- 2.) Terminate bus on both ends with bridge between CAN-H and R_{ab}
- 3.) Adjust transmission speed
- 4.) Set knot address
- 5.) Transmit program form PC to PLC IL 5504 with programming software and store it.

Technical Data

Auxiliary voltage

Auxiliary voltage U_H A1/A2: DC 24 V
Voltage range: 0.8 ... 1.1 U_N
Nominal consumption: 1.4 W

Input

Inputs: 2 digital inputs according to IEC/EN 61131-2 galvanic separated by optocouplers
Input voltage: DC 24 V
Signalverzögerung: approx. 2 ms

Output

Contacts: IL 5504.22: 2 relay outputs
 1 monitoring contact 23-24
Thermal current I_{th}: 2 A
Switching capacity to AC 15: 3 A / AC 230 V IEC/EN 60 947-5-1
Switching capacity: at DC 24 V: 48 W
 at AC 230 V: 460 VA
Short circuit strength max. fuse rating: 4 AgL IEC/EN 60 947-5-1
Mechanical life: > 10⁶ switching cycles

Technical Data

Programming interface RS232

Wire: Null Modem wire link
Transmission parameter: 57.6 KBaud, 8N1
 The auxiliary voltage U_H is not galvanically separated from the programming interface.

CANopen interface

Wire: screened twisted pair
Transmission speed: adjustable 20 Kb/s, 125 Kb/s, 500 Kb/s, 1 Mb/s,

Attention: Both ends of the 2-wire bus have to be terminated with a bridge between CAN_H and R_{ab}. The auxiliary voltage U_H is not galvanically separated from the CANopen interface.

General Data

Buffer for RAM and Realtime clock: 3 years
Cycle time: approx. 10 ms + (0.4 ms per translated 1 Kb user program)
Immunity against phase failure: 20 ms
Operating mode: Continuous operation
Temperature range: - 20 ... + 60°C
Clearance and creepage distances

overvoltage category / pollution degree		
auxiliary voltage, CANopen interface to digital inputs:	1.5 kV / 2	IEC 60 664-1
digital inputs to digital inputs:	1.5 kV / 2	IEC 60 664-1
auxiliary voltage, CANopen interface to relay outputs:	4 kV / 2	IEC 60 664-1
relay outputs to relay outputs:	4 kV / 2	IEC 60 664-1

Technical Data		
EMC		
Electrostatic discharge:	8 kV (air)	IEC/EN 61 000-4-2
HF-irradiation:	10 V/m	IEC/EN 61 000-4-3
Fast transients:	2 kV	IEC/EN 61 000-4-4
Surge voltages between wires for power supply:	1 kV	IEC/EN 61 000-4-5
Interference suppression:	Limit value class B	EN 55 011
Degree of protection		
Housing:	IP 30	IEC/EN 60 529
Terminals:	IP 20	IEC/EN 60 529
Housing: Thermoplastic with V0-behaviour according to UL subject 94		
Vibration resistance: amplitude 0.35 mm frequency 10 ... 55 Hz, IEC/EN 60 068-2-6		
Climate resistance: 20 / 060 / 04 IEC/EN 60 068-1		
Terminal designation: EN 50 005		
Wire connection: 2 x 2.5 mm ² solid or 2 x 1.5 mm ² stranded wire with sleeve DIN 46 228-1/-2/-3/-4		
Wire fixing: Flat terminals with self-lifting clamping piece IEC/EN 60 999-1		
Mounting: DIN rail IEC/EN 60 715		
Weight: 150 g		
Dimensions		
Width x height x depth:		
IL 5504:	35 x 90 x 58 mm	
IN 5504:	52.5 x 90 x 58 mm	

Standard Types	
IL 5504.22 DC 24 V	
Article number:	0054104
• 2 relay outputs	
• 1 monitoring contact	
• 2 digital inputs DC 24 V	
• CANopen interface	
• Auxiliary supply U _H :	DC 24 V
• Width:	35 mm
IN 5504.22 DC 24 V	
Article number:	0055287
• 2 relay outputs	
• 1 monitoring contact	
• 2 digital inputs DC 24 V	
• CANopen interface	
• Auxiliary supply U _H :	DC 24 V
• Width:	52.5 mm

Accessories	
PN 5501:	Programming software Article number: 0052860
OA 5529/180:	Programming cable Article number: 0054950
IP 5502.08:	CANopen module with 8 binary inputs DC 24 V Article number: 0050911
IP 5503.28:	CANopen module with 8 relay outputs Article number: 0050912
IN 5509.23:	CANopen in- / output module with 4 binary inputs DC 24 V und 4 relay outputs Article number: 0055929
IL 5507.90/100:	Analogue output modul; 0 ... 10 V; DC 24 V Article number: 0060372
IL 5507.90/110:	Analogue output modul; 0 ... 20 V; DC 24 V Article number: 0060373
IL 5508.90/100:	CANopen module with 2 analogue inputs 0 ... 10 V Article number: 0056431
IL 5508.90/110:	CANopen module with 2 analogue inputs 0 ... 20 mA Article number: 0056807
IL 5508.90/121:	CANopen module with 2 analogue inputs, PT100 Article number: 0056957
IR 5592:	Power supply for PLC and modules Article number: 0041650
IL 5504:	CANopen PLC

Accessories			
Extension modules for extension bus of IN 5504			
Module type	Type	Article no.	Configuration
Input module	IP 5513.25	0041124	8E DC 24 V
Output module	IP 5513.29	0041128	8A relays
Input module	IL 5513.24	0041121	4E DC 24 V
Output module	IL 5513.28	0041127	4A relays

Application Example IL 5504

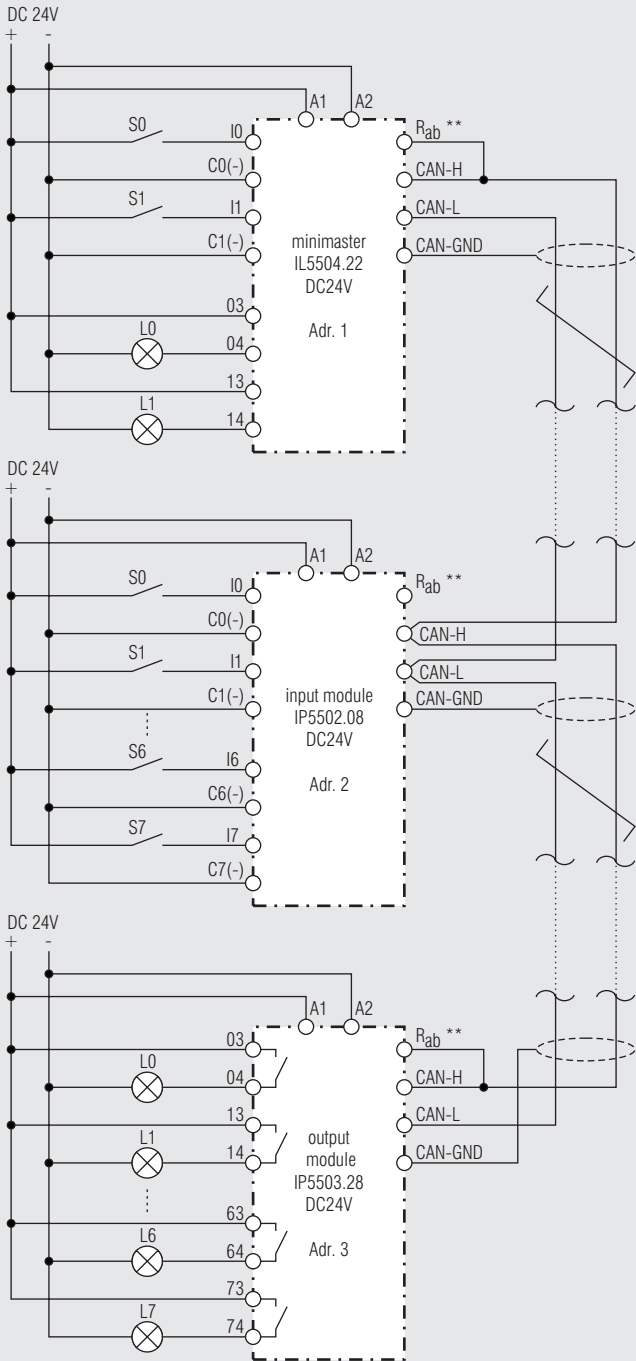

** Both ends of the 2-wire bus have to be terminated with a bridge between CAN-H and R_{ab}.

M7853_d

Application Example

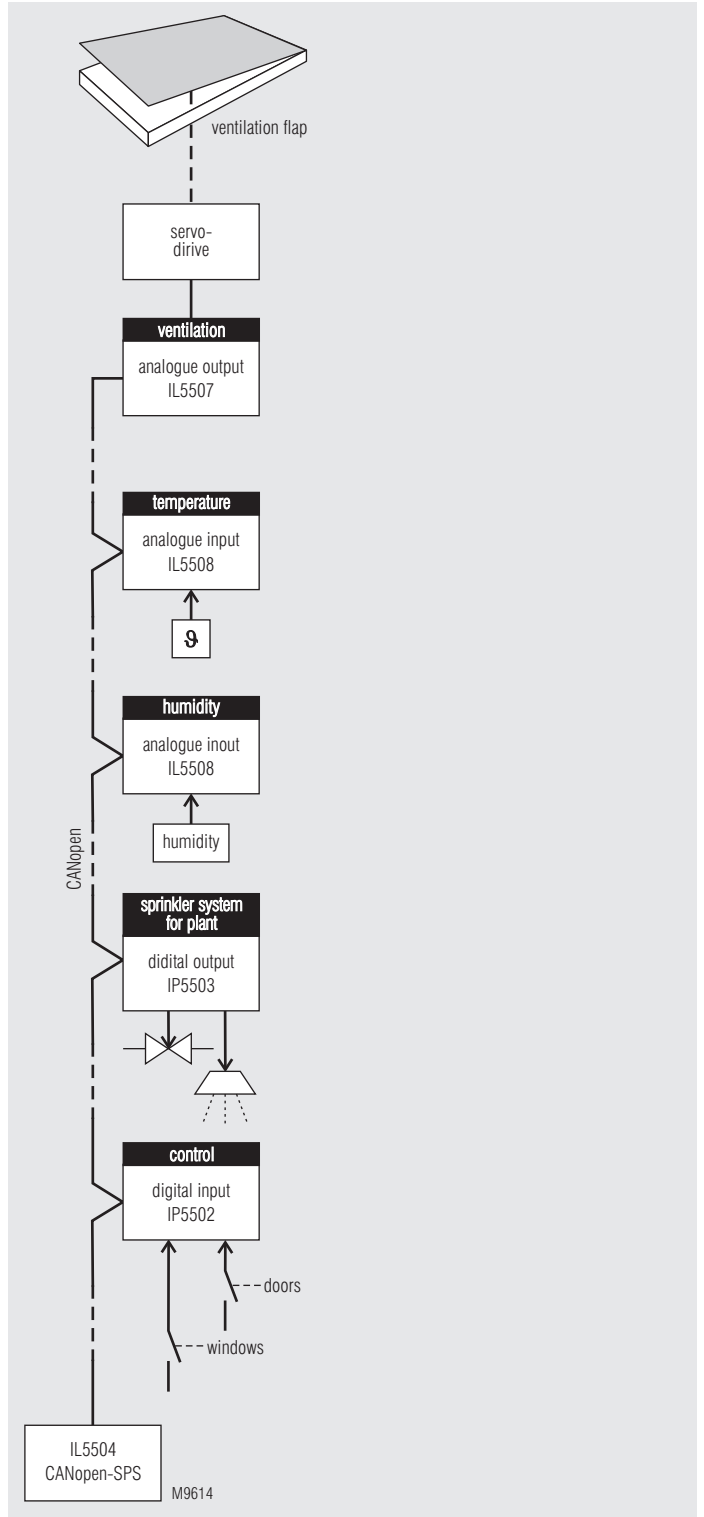

CANopen-application for greenhouses: dependend on temperature- and humidity ventilation flap applications and sprinkler systems for plants in a greenhouse.

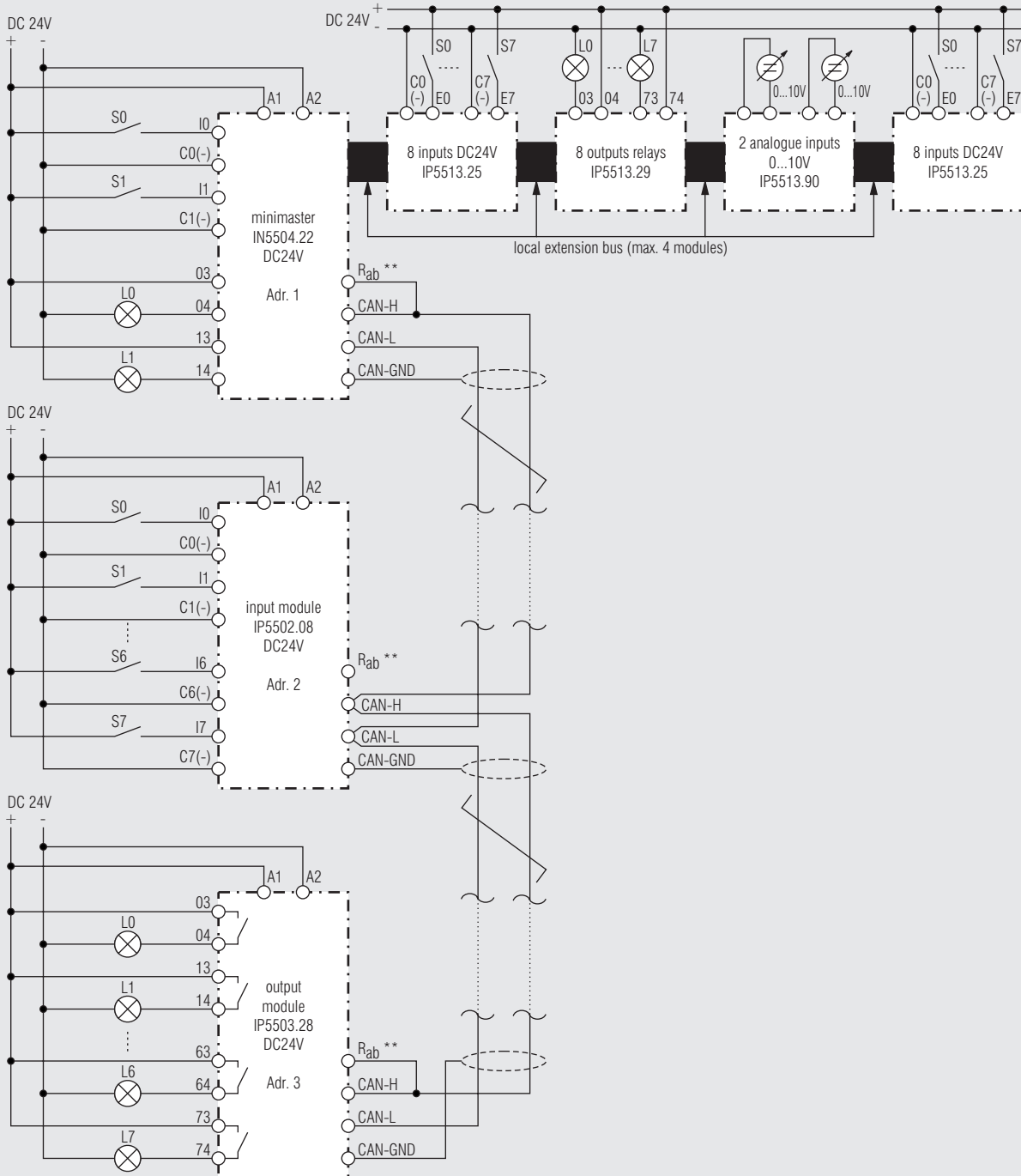

** Both ends of the 2-wire bus have to be terminated with a bridge between CAN-H and Rab.

M8874 a

